

# EXTRACTING FEATURE INFORMATION AND ITS VISUALIZATION BASED ON THE CHARACTERISTIC DEFECT OCTAVE FREQUENCIES IN A ROLLING ELEMENT BEARING

*Jianyu Lei\* and Mingfu Liao*

*Institute of Monitoring and Control for Rotating Machinery and Wind Turbines, Northwestern Polytechnical University, Xi'an, China, 710072*

*\*Email:leijianyu@mail.nwpu.edu.cn*

## **ABSTRACT**

*Monitoring the condition of rolling element bearings and defect diagnosis has received considerable attention for many years because the majority of problems in rotating machines are caused by defective bearings. In order to monitor conditions and diagnose defects in a rolling element bearing, a new approach is developed, based on the characteristic defect octave frequencies. The characteristic defect frequencies make it possible to detect the presence of a defect and diagnose in what part of the bearing the defect appears. However, because the characteristic defect frequencies vary with rotational speed, it is difficult to extract feature information from data at variable rotational speeds. In this paper, the characteristic defect octave frequencies, which do not vary with rotation speed, are introduced to replace the characteristic defect frequencies. Therefore feature information can be easily extracted. Moreover, based on characteristic defect octave frequencies, an envelope spectrum array, which associates 3-D visualization technology with extremum envelope spectrum technology, is established. This method has great advantages in acquiring the characteristics and trends of the data and achieves a straightforward and creditable result.*

**Keywords:** Roller bearings, Roller element bearings; Characteristic defect octave frequencies; 3-D visualization technology; Envelope spectrum array; Extremum envelope spectrum

## **1 INTRODUCTION**

Bearing condition monitoring has received considerable attention for many years because the majority of problems in rotating machines are caused by defective bearings. The typical failure mode for rolling element bearings is localized defects, which occur when a sizable piece of material on the contact surface is dislodged during operation, mostly by fatigue cracking under cyclic contact stress. Therefore detection of these defects is important for condition monitoring as well as quality inspection of the bearings. Different methods are used for detection and diagnosis of bearing defects; they may be broadly classified as vibration and acoustic measurements, temperature measurements, and wear debris analysis. Among these, vibration measurements are the most widely used. Several techniques have been applied to measure the vibration and acoustic responses from defective bearings; i.e., vibration measurements in time and frequency domains, the shock pulse method, sound pressure and sound intensity techniques, and the acoustic emission method (Tandon & Choudhury, 1999).

## 2 FREQUENCY- DOMAIN APPROACH AND THE CHARACTERISTIC DEFECT OCTAVE FREQUENCIES

Frequency-domain or spectral analysis of the vibration signal is perhaps the most widely used approach in bearing defect detection. The advent of modern fast Fourier transform (FFT) analyzers has made the job of obtaining narrowband spectra easier and more efficient. Both low and high frequency ranges of the vibration spectrum are of interest in assessing the condition of the bearing.

Each bearing element has a characteristic rotational frequency. When a defect occurs on a particular bearing element, an increase in vibration energy at this element's rotational frequency may occur. These frequencies are dependent on the geometry of the bearing and its rotational speed (McFadden & Smith, 1984; Tandon & Choudhury, 1999). For a bearing with a stationary outer race, these frequencies are given by the following expressions:

$$\text{outer race defect frequency, } f_{bo} = \frac{N}{2 \times 60} \left(1 - \frac{d}{D_m} \cos \beta\right) \cdot z, \quad (1)$$

$$\text{inner race defect frequency, } f_{bi} = \frac{N}{2 \times 60} \left(1 + \frac{d}{D_m} \cos \beta\right) \cdot z, \quad (2)$$

$$\text{rolling element defect frequency, } f_b = \frac{D_m}{d} \left[1 - \left(\frac{d \cos \beta}{D_m}\right)^2\right] \cdot f, \quad (3)$$

where  $f$  is the shaft rotation frequency,  $d$  is the diameter of the rolling element,  $D_m$  is the pitch diameter,  $z$  is the number of rolling elements, and  $\beta$  is the contact angle.

The location dependent characteristic defect frequencies make it possible to detect the presence of a defect and to diagnose on what part of the bearing the defect is located. The frequency-domain approach is founded on the characteristic defect frequencies. However, because the characteristic defect frequencies vary with rotational speed, it is difficult to extract common feature information from data at varied rotational speeds. In this paper, the characteristic defect octave frequencies, which are determined by bearing geometry and do not vary with rotational speed, are introduced to replace the characteristic defect frequencies. Therefore defect features at different rotational speeds are uniform and can be easily extracted.

For a bearing with a stationary outer race, the characteristic defect octave frequencies considerations are given by the following expressions:

$$\text{outer race defect octave\_frequency, } F_{be} = f_{be}/f = \frac{1}{2} \left(1 - \frac{d}{D_m} \cos \beta\right) \cdot z, \quad (4)$$

$$\text{inner race defect octave frequency, } F_{bi} = f_{bi}/f = \frac{1}{2} \left(1 + \frac{d}{D_m} \cos \beta\right) \cdot z, \quad (5)$$

$$\text{rolling element defect octave frequency, } F_b = f_b/f = \frac{1}{2} \frac{D_m}{d} \left[1 - \left(\frac{d \cos \beta}{D_m}\right)^2\right]. \quad (6)$$

For a type of rolling bearing, because the diameter of the rolling element  $d$ , the pitch diameter  $D_m$ , the number of rolling elements  $z$ , and the contact angle  $\beta$  are known,  $F_b$ ,  $F_{bi}$  and  $F_{be}$  which do not vary with rotate speed are constant.

### **3 THE REFERENCE LINE AND ENVELOPE SPECTRUM ARRAY**

Envelope detection or the high-frequency resonance technique (HFRT) is an important signal processing technique that helps in the identification of bearing defects by extracting characteristic defect frequencies (which may not be present in the direct spectrum) from the vibration signal of the defective bearing. The envelope spectrum may contain a number of overlapping groups of spectral lines, centered at multiples of the characteristic defect frequencies (McFadden, 1984 & 1985). The characteristic defect octave frequencies vary with rotation speed, but the characteristic defect frequencies do not. The relation between a rolling bearing and its characteristic defect octave frequencies is pre-determined. Based on this relation, three kinds of defect reference lines ( $nF_b$ ,  $nF_{bi}$  and  $nF_{be}$ ,  $n = 1, 2, 3 \dots$ ) are applied to the envelope spectrum. Identification of bearing defects becomes easier with the help of the defect reference lines.

Because defect features based on the characteristic defect octave frequencies at different rotation speeds are uniform, the envelope spectrum can be developed into an envelope spectrum array, which associates 3-D visualization technology with extremum envelope spectrum technology. Its great advantage is that it acquires the chief characteristics and trends from the vibration signal in various conditions and achieves straightforward and creditable results.

## **4 EXPERIMENTAL RESULTS**

### **4.1 Experimental Setup**

The experimental setup is shown in Figure 1. Experimental data were collected from the drive end ball bearing of an induction motor driven mechanical system. The support bearings were 35 mm bore, deep groove ball bearings of HH make and designation 6307E. The accelerometer was a B&K type 4343 piezo-electric accelerometer and was mounted on the motor housing at the drive end. Data were gathered for three different conditions: (i) inner race defect; (ii) outer race defect; (iii) ball defect. Defects were introduced into the drive end bearing by the EDM method. For the inner race, outer race and ball defect cases, vibration data for three severity levels (0.25, 0.5, and 1 mm) were collected. All the experiments were repeated for four different load conditions (0, 50, 100, 150, and 300N). The rotation speed for the test varied from 200rpm to 2200rpm at intervals of 50 rpm. The outer race defects were located at the centre of the load zone. Vibration signals were collected through an accelerometer placed on the bearing housing directly above the load zone. The measurement of rotation speed and phase and generation of synchronous integrated period sampling trigger signal were accomplished with GBMD2006.

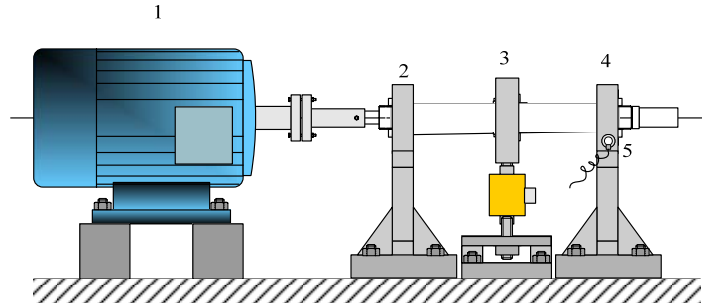

1. D.C. motor, 2. Support bearing housing, 3. Loading arrangement, 4. Support and test bearing housing, 5. Piezo-electric accelerometer

**Figure 1.** Test rig

**Table 1.** Geometrical parameter of the type 6307 rolling bearing

Number of rolling elements $z$	Diameter of the rolling element $d$ /mm	Pitch diameter $D_m$ /mm	Contact angle $\beta$
7	14.5	35	0

**Table 2.** Characteristic defect octave frequencies of the type 6307 rolling bearing

inner race defect $F_{bi}$	outer race defect $F_{be}$	ball defect $F_b$
4.32	2.63	3.72

## 4.2 Results

### 4.2.1 Envelope spectrum with the defect referent lines

The amplitude envelope spectrums obtained from the test bearing with an inner race defect, an outer race defect, and an ball defect under a radial load of 150N are shown in Figures 2 - 4, respectively. Rotation speed need not be taken into account as a result of introducing the characteristic defect octave frequencies into analysis of the vibration signal of the defective bearing. The application of the defect reference lines in the envelope spectrum simplifies the process of the identification of bearing defects. In Figure 1, the chief spectral lines are in accord with the inner race defect reference line, so we can ascertain the signal induced by an inner race. This result agrees with the defect simulation of test bearings. In a like manner, we can examine the envelope spectrum in Figures 3 and 4 and achieve the correct result.

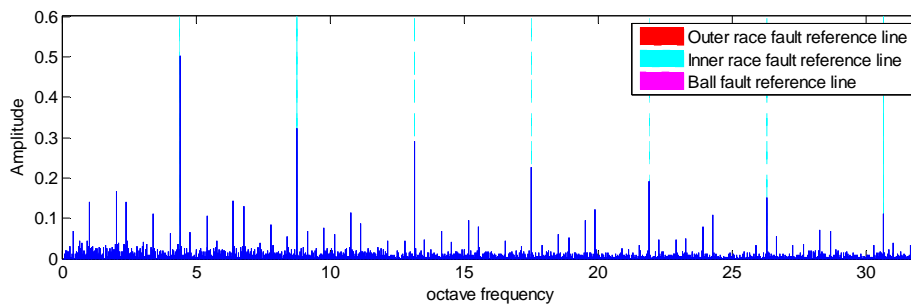

**Figure 2.** The envelope spectrum obtained from the test bearing with an inner race defect under a radial load.

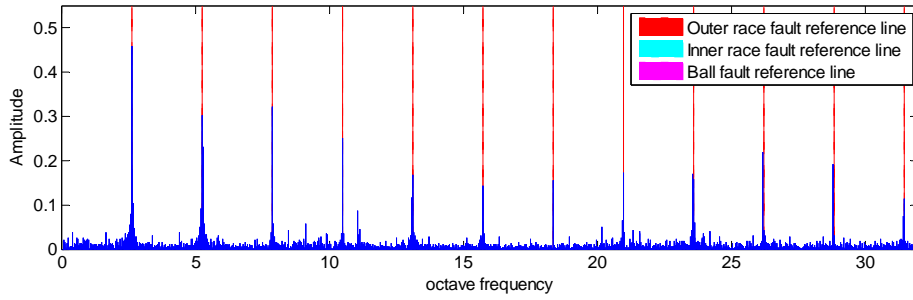

**Figure 3.** The envelope spectrum obtained from the test bearing with an outer race defect under a radial load.

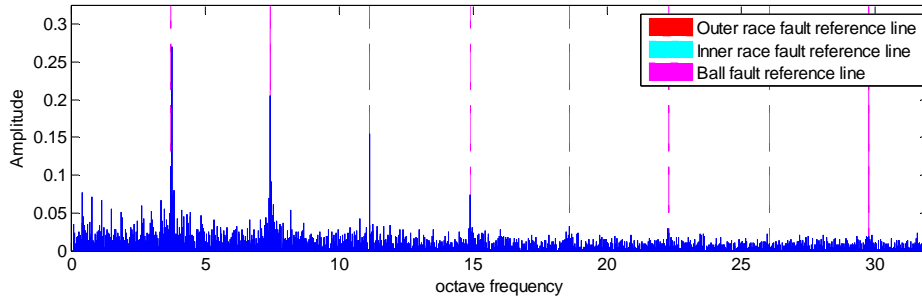

**Figure 4.** The envelope spectrum obtained from the test bearing with a ball defect.

#### 4.2.2 Envelope spectrum array

Envelope spectrum array synthetically analyses data obtained from the test bearing with rotation speed varying from 200rpm to 2200rpm at intervals of 50 rpm. The results of the inner race defect, outer race defect, and ball defect are shown in Figures 5 –7, respectively. The distribution of the characteristic defect octave frequencies in an envelope spectrum array is distinct, that is, the amplitude of the chief defect spectrum lines increase with rotation speed.

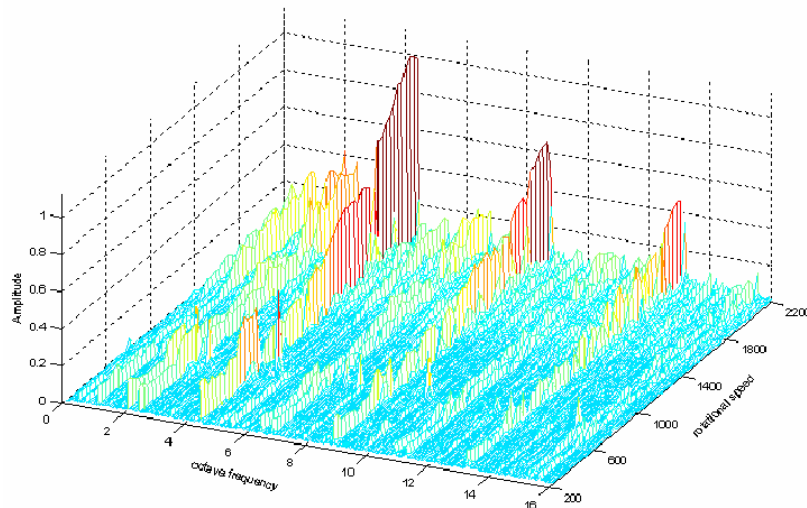

**Figure 5.** The envelope spectrum array obtained from the test bearing with an inner race defect

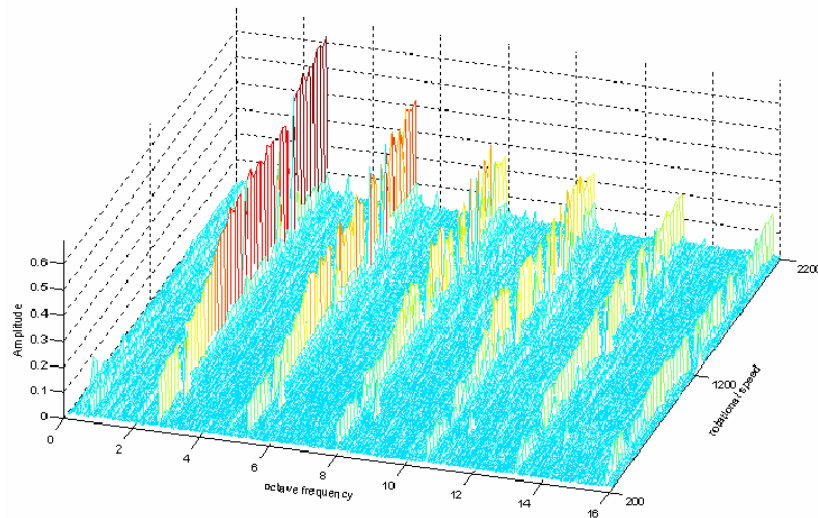

**Figure 6.** The envelope spectrum array obtained from the test bearing with an outer race defect

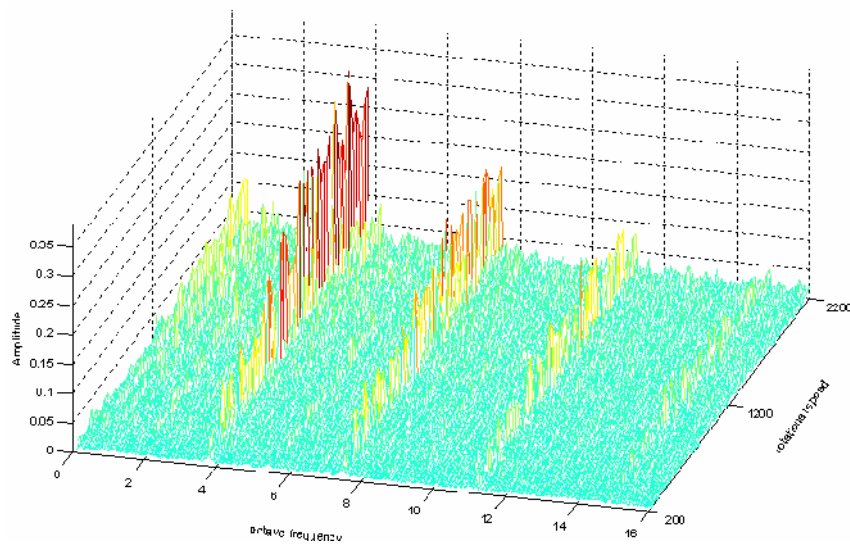

**Figure 7.** The envelope spectrum array obtained from the test bearing with a ball defect

## 5 CONCLUSIONS

Because the characteristic defect frequencies of a rolling bearing vary with rotation speed, it is difficult to extract common feature information from multiform vibrating signals. In this paper, the characteristic defect octave frequencies, which were determined by bearing geometry and do not vary with rotation speed, are introduced to replace characteristic defect frequencies. Thus, the defect features at different rotation speeds are uniform and can be easily extracted.

Moreover, based on characteristic defect octave frequencies, envelope spectrum array, which adopts 3-D visualization technology, is established. This has a great advantage in acquiring data characteristics and trends and achieves a straightforward and creditable result. An experiment with defect bearings illustrates that this approach is an effective short cut.

## **6 REFERENCES**

McFadden, P. (1984) Model for the vibration produced by a single point defect in a rolling element bearing. *Journal of Sound and Vibration* 96: 69-82.

McFadden, P. (1985) The vibration produced by multiple point defects in a rolling element bearing. *Journal of Sound and Vibration* 98: 263-273.

McFadden, P. & Smith, J. (1984) Vibration monitoring of rolling element bearings by the high frequency resonance technique —a review. *Tribology International* 17(1): 3-10.

Tandon, N. & Choudhury, A. (1999) A Review of Vibration and Acoustic Measurement Methods for the Detection of Defects in Rolling Element Bearings. *Tribology International* 32: 469 -480.